



# In-Motion Automatic Satellite System

with built-in DVB for positive satellite identification

## Model V30

### Installation and Operating Instructions

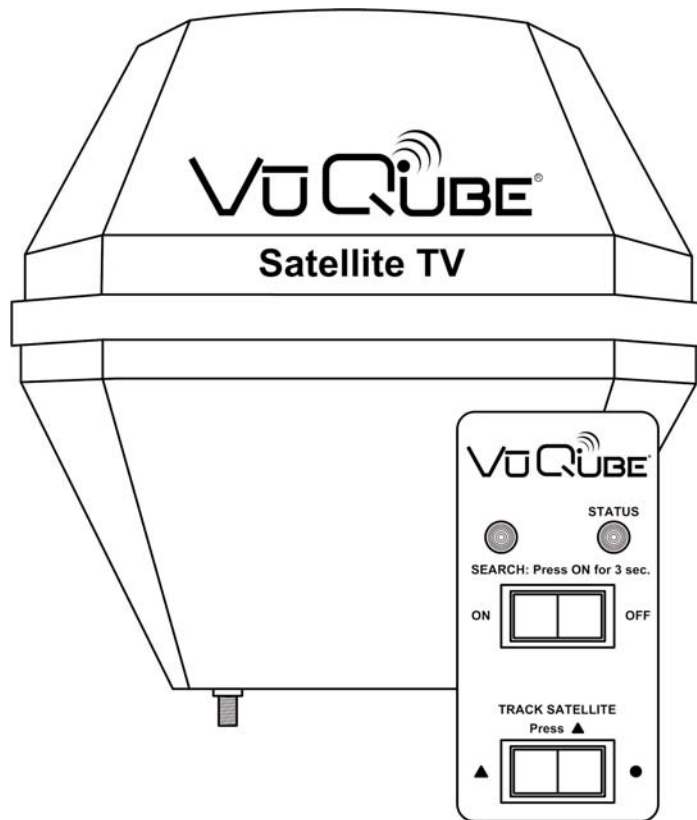

*Satellite Solutions for Mobile Markets*

11200 Hampshire Avenue South, Bloomington, MN 55438-2453  
Phone: (800) 982-9920 Fax: (952) 922-8424

[www.kingcontrols.com](http://www.kingcontrols.com)



## IMPORTANT!

The satellite TV market is expanding and changing. The information in this manual was accurate at the time of printing. If your VuQube does not operate as outlined in this manual please call King Controls at (800) 982-9920 or visit our website at [www.kingcontrols.com](http://www.kingcontrols.com).

This VuQube is factory pre-set for DIRECTV® standard digital programming broadcast from the 101° W satellite.

If you also receive your local channels from DIRECTV's 119 satellite or if you subscribe to Dish Network™ or ExpressVu programming, you must re-configure the antenna to work with your satellite service. Doing this will allow the VuQube to lock on the correct satellites to receive your programming and also enable automatic satellite switching via the receiver's remote control for multi-satellite service.

Antenna configuration is a one time procedure that **MUST BE COMPLETED** before using your VuQube antenna. See the VUQUBE ANTENNA CONFIGURATION section in this manual for specific instructions.

Please read this entire manual before beginning the installation.

## TABLE OF CONTENTS

Section	Contents	Page
1.	INTRODUCTION.....	2
2.	INSTALLATION.....	3-7
3.	VUQUBE ANTENNA CONFIGURATION.....	9-19
4.	OPERATION.....	20-23
5.	TROUBLESHOOTING.....	24
6.	MAINTENANCE.....	25
7.	LIMITED WARRANTY.....	26

The VuQube V30 Automatic Satellite System provides simple, one-touch operation for easy access to all your favorite satellite TV channels. It is a full featured dish system with automatic satellite acquisition, satellite switching and in-motion capabilities.

The V30 is compatible with the following satellite services:

DIRECTV® Single Satellite  
 DIRECTV Plus  
 Dish Network Dish 500 and Dish 500 Eastern Arc  
 Dish Network HDTV (Dish HD, Dish HD Eastern Arc, and Dish HD Alternate)  
 ExpressVu  
 ExpressVu HDTV

The V30 includes 2 main components (**Fig. 1**).

Antenna Unit	Located on the outside of the vehicle. The dish is covered by a protective enclosure that keeps operational components free from the elements.
Controller	Located in the vehicle. Activates the search mode and provides limited diagnostic functions using the status light.

Note: A TV, satellite receiver, and program subscription are also required for satellite TV viewing.  
 (Sold separately.)

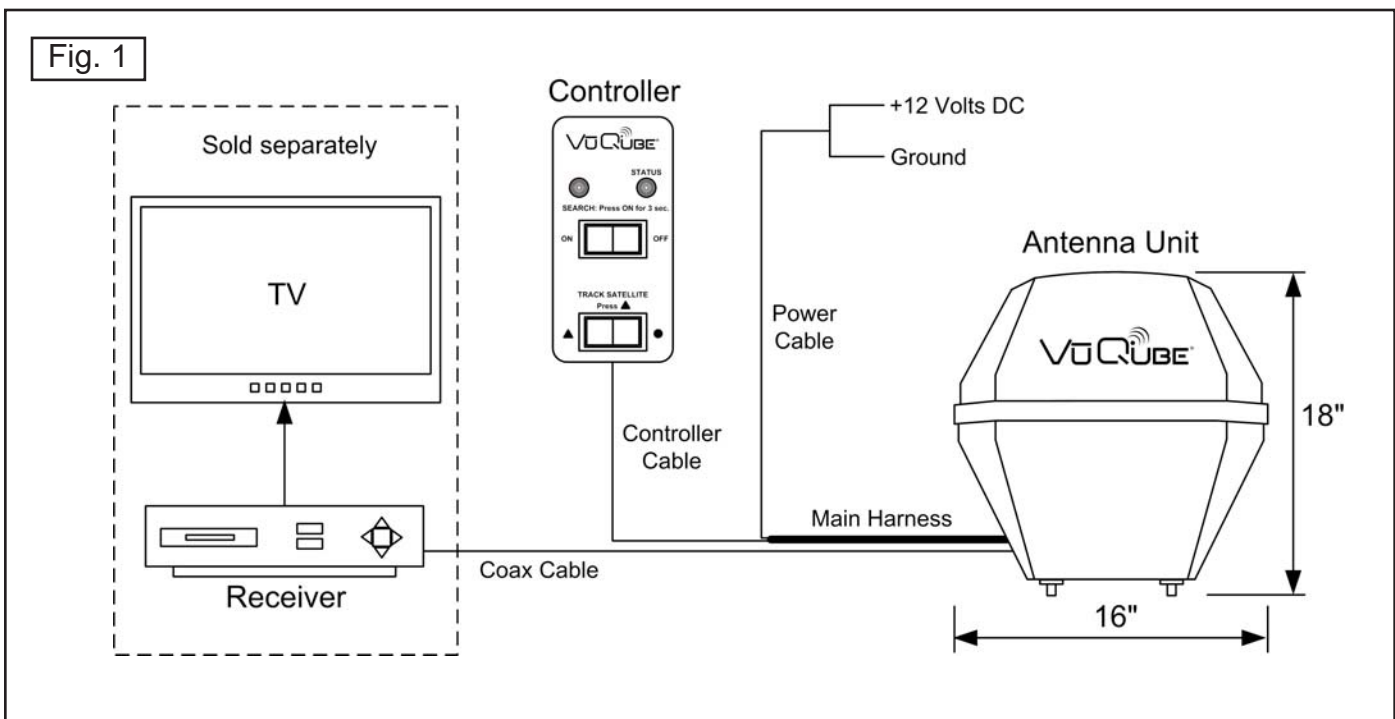

## TOOLS AND MATERIALS REQUIRED

1. Read thru the instructions and make sure you have all the tools and materials required to complete the installation, including:
  - mounting bracket (*sold separately - for more information call King Controls at 800-982-9920 or visit our website at [www.kingcontrols.com](http://www.kingcontrols.com)*)
  - drill and drill bit set
  - tape measure
  - 7/16" open end wrench (coax connections)
  - adhesive sealant (compatible with cab material)
  - appropriate tools and fasteners to install all components and wiring

## KIT CONTENTS

2. Unpack and identify all components (**Fig. 2**).

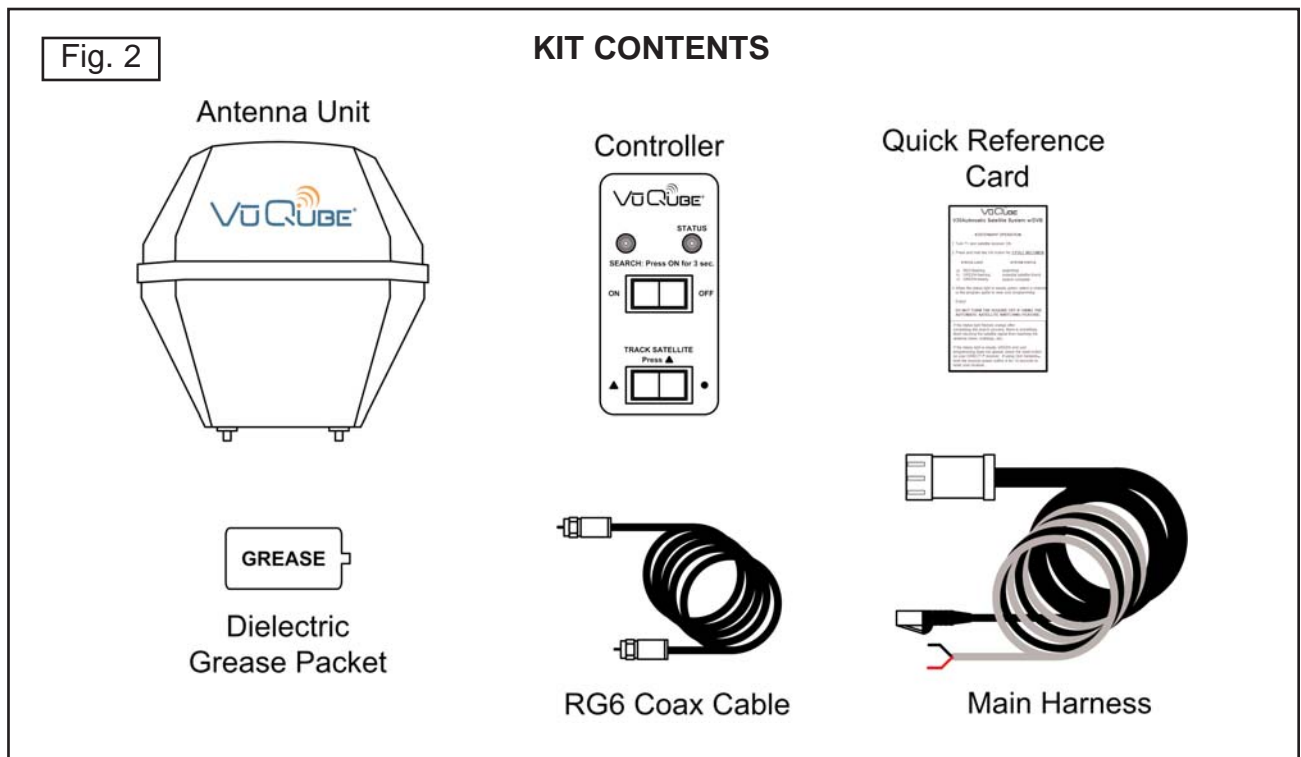

## ANTENNA UNIT LOCATION AND INSTALLATION (FIG 3.)

**IMPORTANT!** The antenna unit **MUST** be mounted to the air ride cab, **NEVER** to any structure mounted directly to the frame (for example the headache rack). Mounting directly to the frame will void the VuQube warranty.

3. Determine the location of the antenna unit using the following criteria:
  - a) The antenna unit is designed to be mounted to a vehicle with an appropriate mounting bracket such as the MB100 or MB200 (*sold separately - for more information call King Controls or visit our website at [www.kingcontrols.com](http://www.kingcontrols.com)*).
  - b) The antenna unit requires a 16" wide space for mounting.
  - c) It is highly recommended that the antenna unit extend a minimum of 4" above the highest point of the cab or air shield for optimum satellite reception.

If you are unable to mount the antenna unit 4" above the cab due to height restrictions, install with maximum clearance available. If the antenna unit is not high enough, you may experience difficulty acquiring the satellite signal.
  - d) The antenna unit should be as far as possible from objects like smoke stacks, beacons, logistic units, etc. that can physically block the satellite signal.
  - e) The wiring from the antenna unit may be run down the back of the cab and up into the cab through an access bay, or a hole may be drilled in an appropriate location. There must be no sharp bends in the wiring.

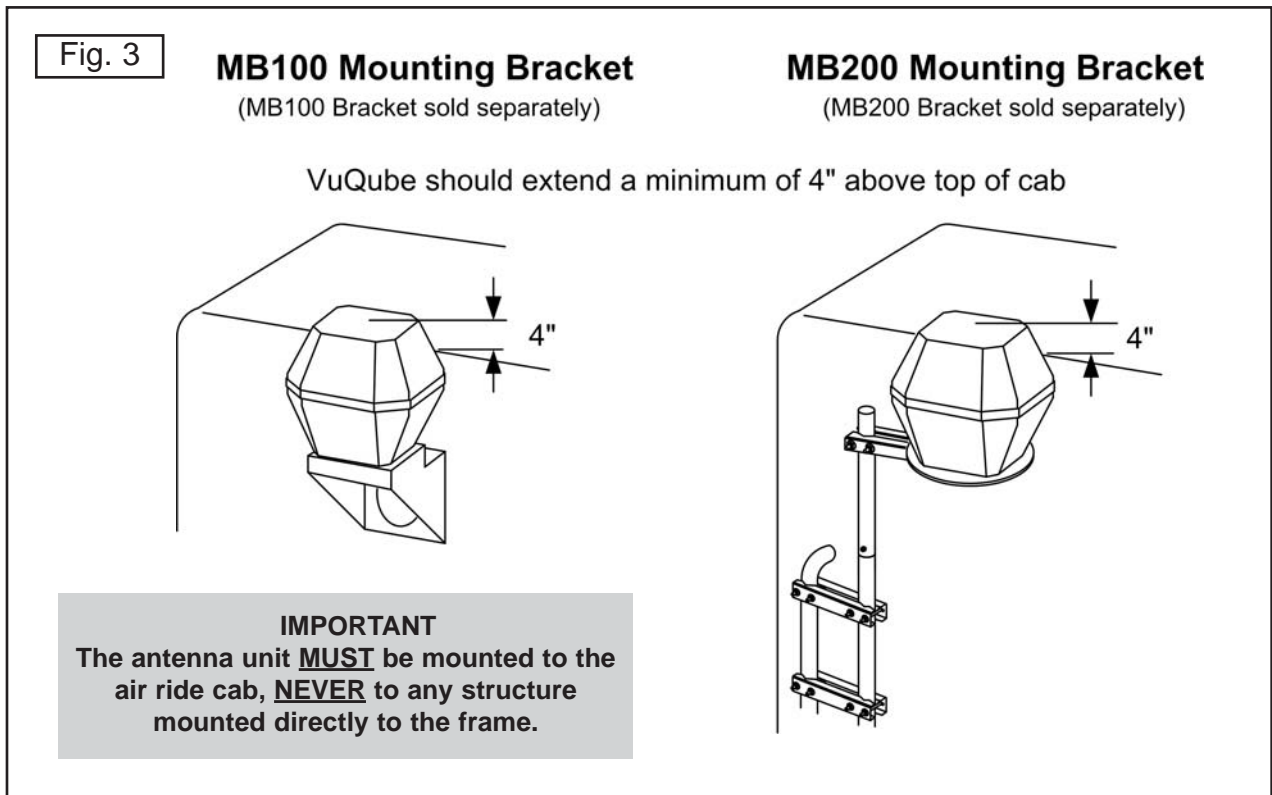

Note: The installer is responsible for determining the most appropriate fasteners to secure the mounting bracket to the cab, and they should always be used in combination with a cab compatible sealant.

**IMPORTANT! The installer is responsible for weatherproofing all holes with sealant.**

4. Mount the bracket to the cab (*see bracket instructions-bracket sold separately*). Remove the nuts from the threaded studs on the bottom of the antenna unit. Insert the antenna unit thru the bracket and fasten down securely with nuts. **THE WIRING CONNECTIONS MUST FACE FORWARD (TOWARD THE FRONT OF THE VEHICLE).**

## EXTERNAL WIRING

5. Plug main harness into wiring port on back of antenna unit and tighten connection until it clicks past the detent lock (**Fig. 4**).

Note: The VuQube is wired for multiple receiver support. There are two coax ports on the back of the unit. The one labeled "MAIN" **MUST** be connected to the main receiver in the vehicle. This receiver will control automatic satellite switching if applicable. The one labeled "AUX" can be used for an additional receiver.

**IMPORTANT! You must fill the ends of the external coax cables with the supplied dielectric grease. Failure to do so will void warranty.**

6. Fill end of coax cable that will connect to the MAIN port on the antenna unit with supplied dielectric grease. Connect this end of the coax cable to the MAIN port and tighten connection (**Fig. 4**).

If using a second receiver, fill end of second coax cable (not supplied) and connect it to the port labeled AUX. Tighten connection.

**DO NOT OVER TIGHTEN CONNECTIONS.**

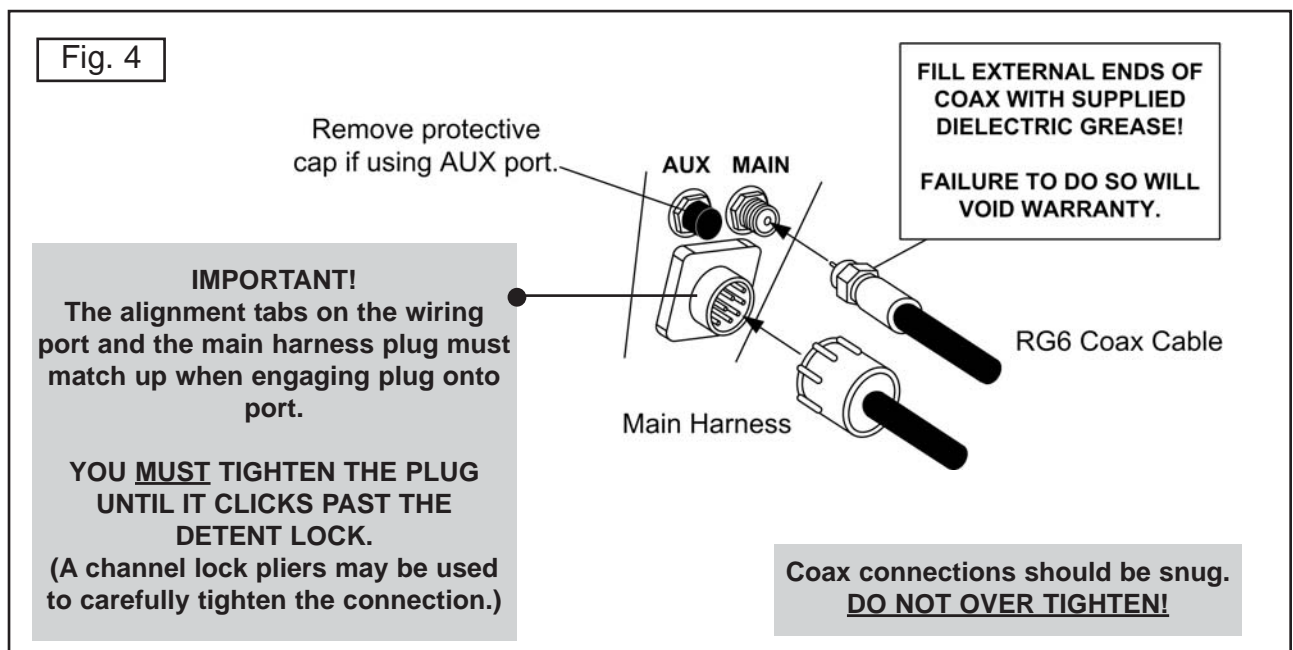

## AVOID SHARP BENDS WHEN ROUTING COAX!

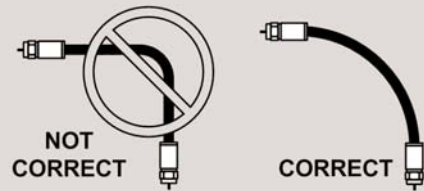

7. Run wiring from the antenna unit to the location where it will be fed into the vehicle. Make sure external wiring is tied down securely (to a hand rail for example) (**Fig. 5**).
8. Drill 3/4" hole through the cab or use an existing hole to feed the wiring inside the cab. Seal opening with cab compatible sealant so that it is entirely waterproof (inside and outside of the hole).

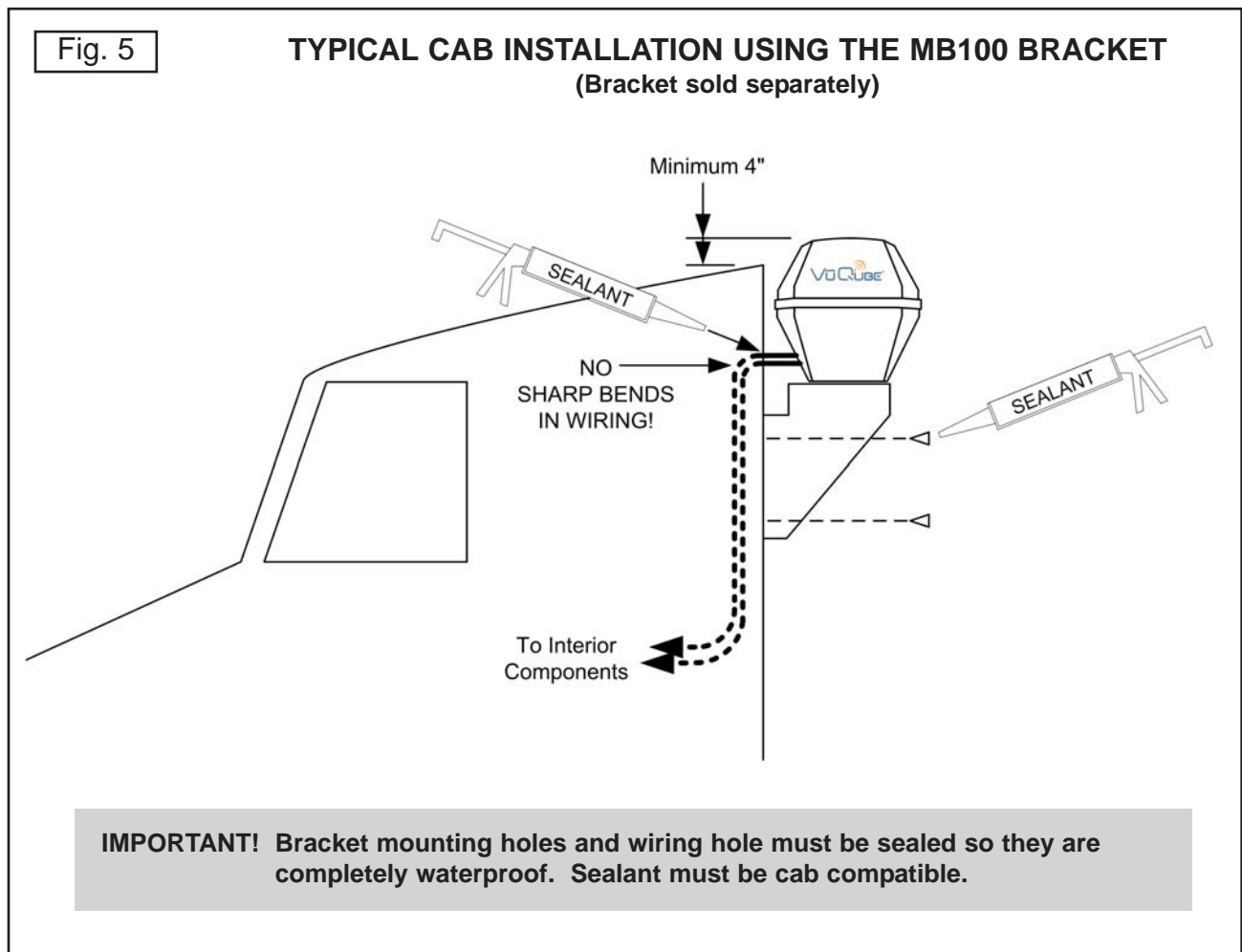



## INTERNAL WIRING

9. Inside the vehicle, make the connections as shown in **(Fig. 6)**, keeping in mind the following important points:
  - a) **The connection between the antenna unit and the receiver must be a direct connection with no devices in between.**
  - b) **Power connection must be a non-shared circuit.** Excessive current draw on the circuit will cause the unit to operate improperly. Power and ground connections must be made after the main harness is plugged into the antenna unit.
  - c) **If fusing the circuit, the fuse must be rated at 7.5 amps.**

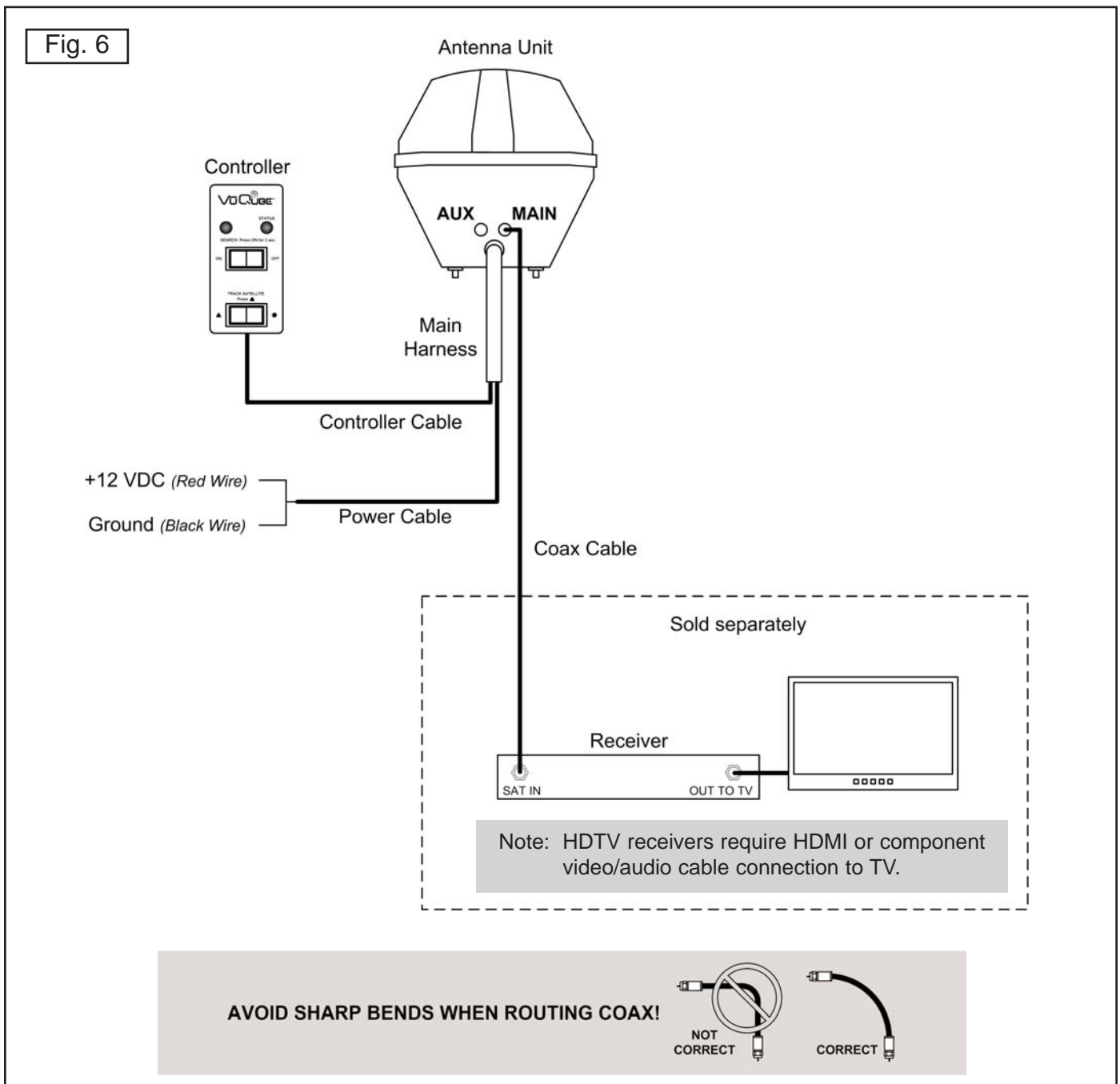



This page intentionally left blank.

The VuQube Model V30 Automatic Satellite System is factory pre-set for DIRECTV standard digital programming broadcast from the 101° W satellite.

If you also receive your local channels from DIRECTV's 119 satellite or if you subscribe to Dish Network or ExpressVu programming, you must use the VuQube hand held controller to re-configure the antenna to work with your satellite service. Doing this will allow the VuQube to lock on the correct satellites to receive your programming and also enable automatic satellite switching via the receiver's remote control for multi-satellite service.

Antenna configuration is a one time procedure that **MUST BE COMPLETED** before using your VuQube antenna. To configure your antenna, follow these steps:

### 1. SATELLITE SERVICE OPTIONS

Determine the service you want to program (pages 10-11).

### 2. ANTENNA CONFIGURATION

Configure the antenna for the service you chose in step 1.

On pages 12-16, find your service and follow the instructions in the box.

#### **DIRECTV**

Single Satellite 101 (Factory Pre-set) . . . . .Page 12

DIRECTV Plus . . . . .Page 12

#### **Dish Network**

Dish 500 . . . . .Page 13

Dish 500 Eastern Arc . . . . .Page 13

Dish HD . . . . .Page 14

Dish HD Eastern Arc . . . . .Page 14

Dish HD Alternate . . . . .Page 15

#### **Bell ExpressVu**

Standard Digital 91 . . . . .Page 16

HDTV 82/91 . . . . .Page 16

### 3. DISH AND EXPRESSVU CHECK SWITCH PROCEDURE

For all Dish Network and ExpressVu services:

Configure your receiver for mobile use by running a check switch (page 18).

# STEP 1: SATELLITE SERVICE OPTIONS

## DIRECTV

### Single Satellite 101

Receive programming from the DIRECTV 101 satellite only.

### DIRECTV Plus: 101, 119

Automatically switch between the 101 and 119 satellites for DIRECTV.

**IMPORTANT!** This VuQube is factory ready to receive available HDTV programming from DIRECTV Ku band satellites at 101° and 119°. It will not receive channels broadcast from DIRECTV's Ka band satellites at 99° and 103°.

## BELL EXPRESSVU

(May not be available in all areas due to service provider limitations.)

### Standard Digital 91

Receive programming from the 91 satellite only.

### HDTV 82/91

Automatically switch between the 82 and 91 satellites for Bell ExpressVu by using the receiver's remote control.

# STEP 1: SATELLITE SERVICE OPTIONS

## DISH NETWORK

### Dish 500

Automatically switch between the 110 and 119 satellites for Dish Network by using the receiver's remote control.

### Dish 500 Eastern Arc

Automatically switch between the 62 and 72 satellites for Dish Network by using the receiver's remote control.

### Dish HD & Dish HD Eastern Arc

Dish Network HD programming is broadcast from multiple satellites including these two trios: the Dish HD Trio - 110, 119, 129 satellites, and the Dish HD Eastern Arc Trio - 62, 72, 77 satellites. The map below shows the approximate coverage for each trio.

The VuQube antenna can be easily configured to work with either trio. By choosing the appropriate trio based on where you are, you can receive all of your desired programming.

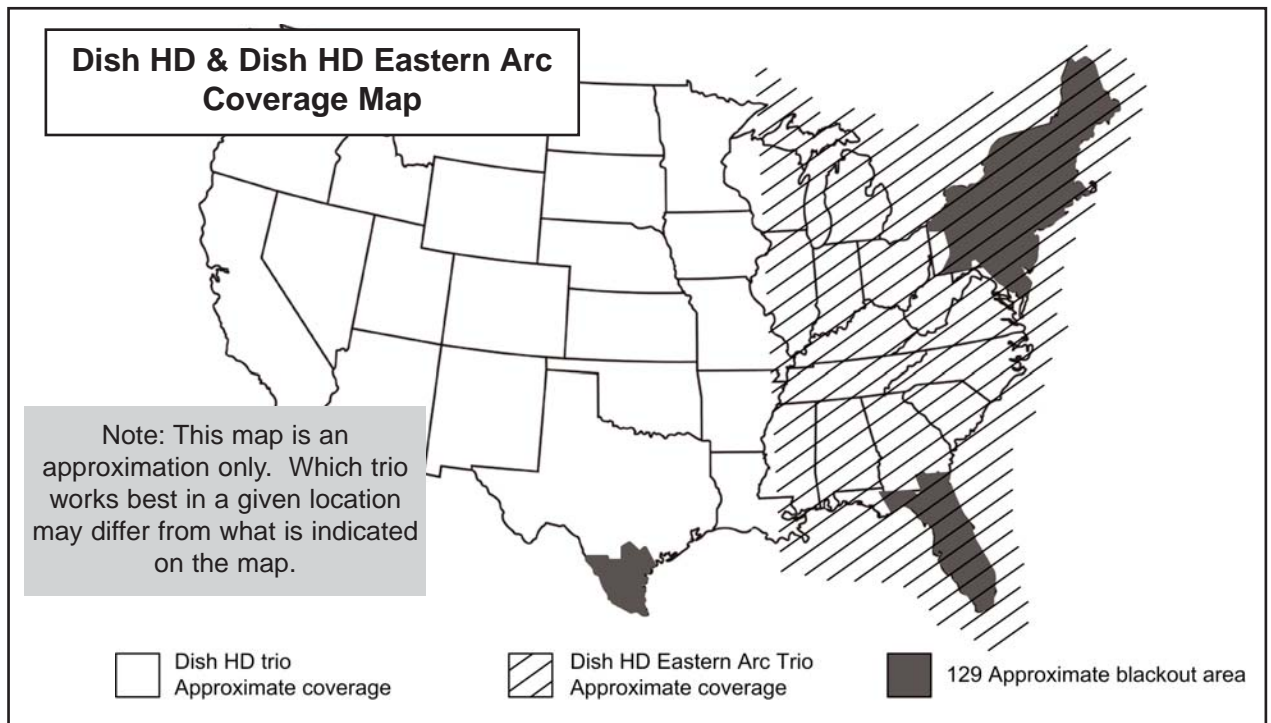

### Dish HD Alternate Trio

Choose this option only if you are unable to view your programming with Dish HD or Dish HD Eastern Arc.

## STEP 2: DIRECTV ANTENNA CONFIGURATION

### Single Satellite 101

The VuQube is factory pre-set for the DIRECTV 101 satellite. Unless the antenna has been configured for another option since leaving the factory, **PERFORM STEP 5 ONLY.**

1. On the VuQube controller, press and release the ON button. Wait for the status light to flash orange, and then **WAIT 4 MORE SECONDS.**
2. Press and release the ON button **16** times. The status light starts rapidly flashing green and red.
3. Press and hold the ▲ button for 4 seconds. The status light will turn orange for 1 second, and then start flashing green or red.
4. Press OFF.
5. Set your receiver for round dish-1 satellite (do this through the receiver's satellite set-up menu screens). Configuration is complete. **Go to page 20.**

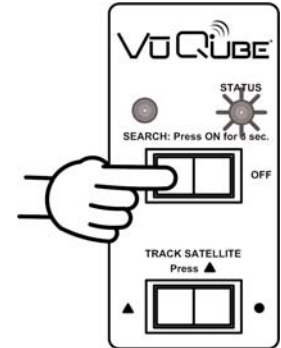

### DIRECTV Plus (satellites 101, 119)

1. On the VuQube controller, press and release the ON button. Wait for the status light to flash orange, and then **WAIT 4 MORE SECONDS.**
2. Press and release the ON button **8** times. The status light starts rapidly flashing green and red.
3. Press and hold the ● button for 4 seconds. The status light will turn orange for 1 second, and then start flashing green or red.
4. Press OFF.
5. Set your receiver for oval dish-2 satellites (do this through the receiver's satellite set-up menu screens). Configuration is complete. **Go to page 20.**

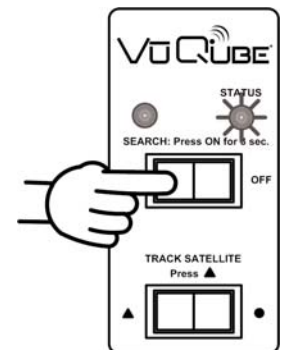

## STEP 2: DISH NETWORK ANTENNA CONFIGURATION

### DISH 500 (satellites 110, 119)

1. On the VuQube controller, press and release the ON button. Wait for the status light to flash orange, and then **WAIT 4 MORE SECONDS**.
2. Press and release the ON button **12** times. The status light starts rapidly flashing green and red.
3. Press and hold the ● button for 4 seconds. The status light will turn orange for 1 second, and then start flashing green or red.
4. Press OFF.
5. After you have successfully configured the antenna, you must configure your receiver for mobile use. To configure your receiver, **GO TO PAGE 18 AND RUN THE CHECK SWITCH.**

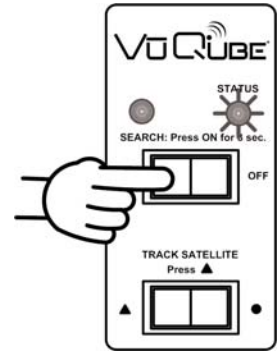

### DISH 500 Eastern Arc (satellites 62, 72)

1. On the VuQube controller, press and release the ON button. Wait for the status light to flash orange, and then **WAIT 4 MORE SECONDS**.
2. Press and release the ON button **36** times. The status light starts rapidly flashing green and red.
3. Press and hold the ON button for 4 seconds. The status light will turn orange for 1 second, and then start flashing green or red.
4. Press OFF.
5. After you have successfully configured the antenna, you must configure your receiver for mobile use. To configure your receiver, **GO TO PAGE 18 AND RUN THE CHECK SWITCH.**

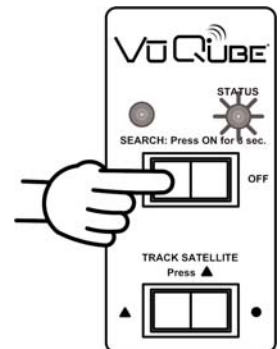

## DISH HD (satellites 110, 119, 129)

1. On the VuQube controller, press and release the ON button. Wait for the status light to flash orange, and then **WAIT 4 MORE SECONDS**.
2. Press and release the ON button **20** times. The status light starts rapidly flashing green and red.
3. Press and hold the ● button for 4 seconds. The status light will turn orange for 1 second, and then start flashing green or red.
4. Press OFF.
5. After you have successfully configured the antenna, you must configure your receiver for mobile use. To configure your receiver, **GO TO PAGE 18 AND RUN THE CHECK SWITCH.**

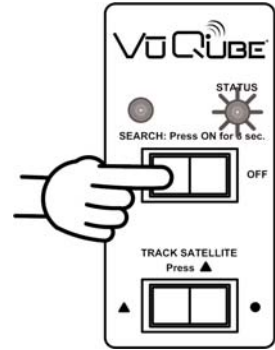

## DISH HD Eastern Arc (satellites 62, 72, 77)

1. On the VuQube controller, press and release the ON button. Wait for the status light to flash orange, and then **WAIT 4 MORE SECONDS**.
2. Press and release the ON button **12** times. The status light starts rapidly flashing green and red.
3. Press and hold the ▲ button for 4 seconds. The status light will turn orange for 1 second, and then start flashing green or red.
4. Press OFF.
5. After you have successfully configured the antenna, you must configure your receiver for mobile use. To configure your receiver, **GO TO PAGE 18 AND RUN THE CHECK SWITCH.**

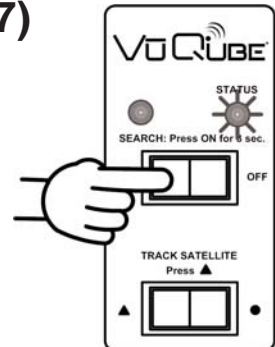



## DISH HD Alternate (satellites 62, 110, 119)

1. On the VuQube controller, press and release the ON button. Wait for the status light to flash orange, and then **WAIT 4 MORE SECONDS**.
2. Press and release the ON button **16** times. The status light starts rapidly flashing green and red.
3. Press and hold the ● button for 4 seconds. The status light will turn orange for 1 second, and then start flashing green or red.
4. Press OFF.
5. After you have successfully configured the antenna, you must configure your receiver for mobile use. To configure your receiver, **GO TO PAGE 18 AND RUN THE CHECK SWITCH.**

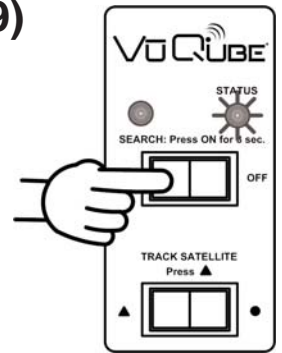

## STEP 2: BELL EXPRESSVU ANTENNA CONFIGURATION

### Standard Digital (satellite 91)

1. On the VuQube controller, press and release the ON button. Wait for the status light to flash orange, and then **WAIT 4 MORE SECONDS**.
2. Press and release the ON button **8** times.  
The status light starts rapidly flashing green and red.
3. Press and hold the ▲ button for 4 seconds.  
The status light will turn orange for 1 second, and then start flashing green or red.
4. Press OFF.
5. After you have successfully configured the antenna, you must configure your receiver for mobile use. To configure your receiver, **GO TO PAGE 18 AND RUN THE CHECK SWITCH.**

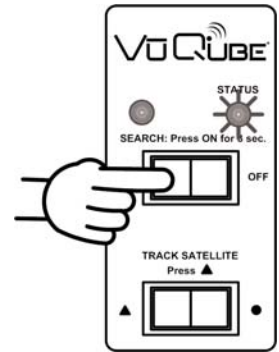

### HDTV (satellites 82, 91)

1. On the VuQube controller, press and release the ON button. Wait for the status light to flash orange, and then **WAIT 4 MORE SECONDS**.
2. Press and release the ON button **36** times.  
The status light starts rapidly flashing green and red.
3. Press and hold the ▲ button for 4 seconds.  
The status light will turn orange for 1 second, and then start flashing green or red.
4. Press OFF.
5. After you have successfully configured the antenna, you must configure your receiver for mobile use. To configure your receiver, **GO TO PAGE 18 AND RUN THE CHECK SWITCH.**

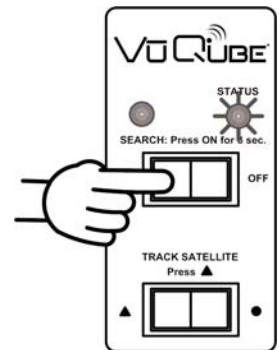



This page intentionally left blank.

# STEP 3: DISH AND EXPRESSVU CHECK SWITCH PROCEDURE

**IMPORTANT! YOU MUST HAVE COMPLETED THE ANTENNA CONFIGURATION BEFORE RUNNING THE CHECK SWITCH.**

For automatic satellite switching, King Controls recommends using a Dish Network model 311 receiver for Dish 500, and a Dish Network model VIP211 or a VIP211k HDTV receiver for Dish HD/HD Eastern Arc/HD Alternate. Do not use dual tuner receivers or recorders.

If you do not have a clear view of the satellites, the switch will not load.

Note: The SW21 and SW64 switches are a receiver software configuration that is loaded into the receiver after running a check switch test with the dish locked on and configured for the appropriate service.

This one time procedure will not need to be repeated after successful installation, unless a) check switch test is run again while connected to a home dish system, b) check switch is run when a receiver is not connected, or c) you travel outside the coverage area of the pre-set satellite trio and switch trios (Dish HD/HD Eastern Arc).

1. Turn on the TV and satellite receiver.
2. On the VuQube controller, press and hold the ON button for **3 FULL SECONDS**.

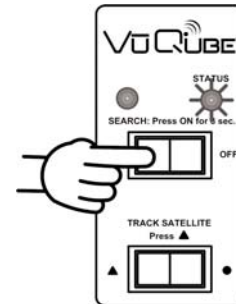

The antenna will lock onto the appropriate satellites before completing the search process.

**After the satellites have been located and the acquisition process is complete, the status light will be steady green.**

3. On the receiver remote, press menu, 6, 1, 1.
4. Highlight Check Switch and press select.

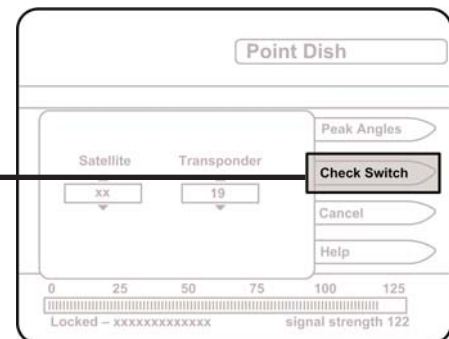

5. Make sure Superdish and Alternate boxes are **NOT** selected.
6. Highlight Test and press Select.

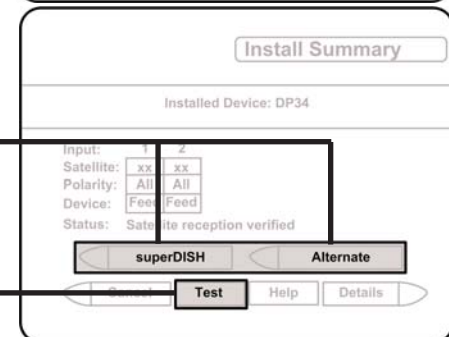

Screen graphics may vary.

The unit will perform a check switch test, and the dish will periodically move back and forth. (This process will take several minutes.)

7. When test is complete, a screen similar to one of the following should appear:  
(Screen graphics may vary.)

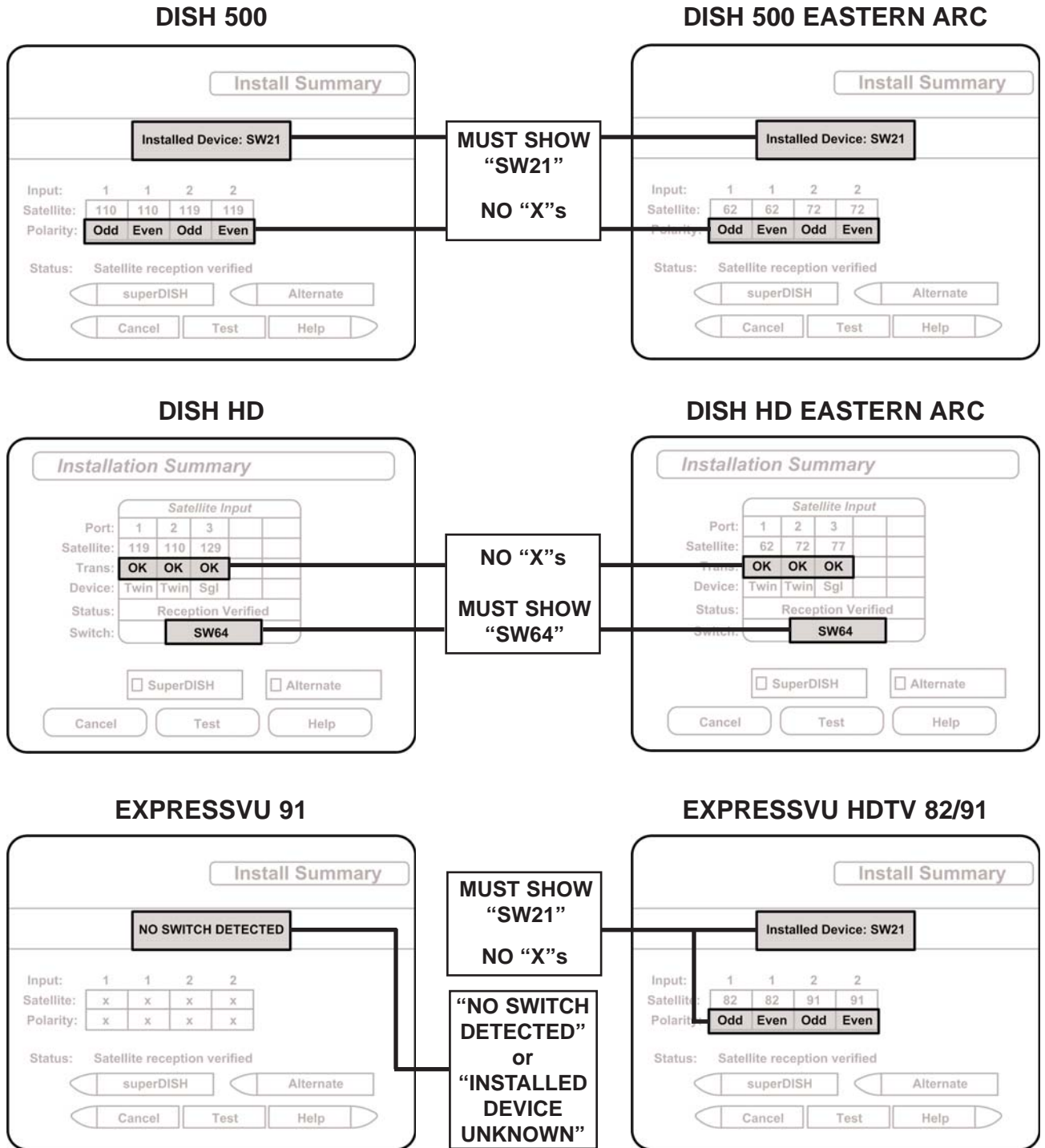

If indicated results are not obtained, go back to Step 3 and run test again. Contact King Controls if the check switch fails to load after 4 attempts.

8. Save the settings, exit to the main menu screen and wait for programming to download.
9. **DISH HD and Dish HD Eastern Arc only:** Verify your saved settings show your desired satellite trio (62, 72, 77 or 110, 119, 129). To switch trios, see page 22.

Configuration is complete. Go to page 20, OPERATION.

**IMPORTANT:** There must be a clear “line of sight” to the southern sky. Mountains, buildings, trees, telephone poles, etc. can all block the satellite signal from reaching the dish.

The distance driven since last performing a search may affect how long it takes the VuQube to find the satellite.

Satellite TV and receiver technology are constantly changing. If you experience difficulty go to [www.kingcontrols.com](http://www.kingcontrols.com) or contact the King Controls Service Department at (800) 982-9920.

## STATIONARY SEARCH

1. Turn on TV and Receiver. “Searching for Satellite” or similar will appear on TV screen.

2. On VuQube controller, press and hold the ON button for **3 FULL SECONDS**.

Power light turns steady GREEN.

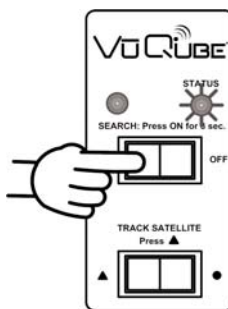

### STATUS LIGHT

- a) flashes a variety of colors for about 30 seconds
- b) RED-flashing
- c) GREEN-flashing (may start flashing RED again)
- d) GREEN-steady

### SYSTEM STATUS

- unit performs self-diagnostic
- search in progress
- potential satellite found
- satellite(s) found and search is complete

3. When the status light is steady green, select a channel or the program guide to view your programming. Enjoy! **(DO NOT TURN THE VUQUBE OFF IF USING THE AUTOMATIC SATELLITE SWITCHING FEATURE.)**

Note: If the status light is steady GREEN and your programming does not appear, press the reset button on your DIRECTV receiver. If using Dish Network, hold the receiver power button in for 10 seconds to reset your receiver. Consult your receiver owner’s manual for further details. (Note that it may take several minutes for the guide to re-download.)

When receiver reset is complete and the guide is downloaded, select a channel or the program guide to view your programming.

## IN-MOTION OPERATION

1. Perform a stationary search as shown on the previous page.
2. Allow your programming to download.

3. Press ▲

<b>STATUS LIGHT</b>	<b>SYSTEM STATUS</b>
alternating colors	initializing
GREEN-flashing	potential satellite found
GREEN-steady	target satellite found (tracking)

When the status light is steady green, the target satellite is found and the unit is tracking.

### ALTERNATE SEARCH METHOD (Above method is the manufacturer's preferred method)

1. Press ON.
2. Press ▲. Before putting the vehicle into motion, wait for the status light to turn steady green and your programming to download.

Note: While driving and in tracking mode, objects such as bridges, buildings and trees may occasionally block the satellite signal from reaching the antenna. Line of sight obstructions may cause the picture on your TV to freeze, pixel or be lost temporarily. PLEASE BE PATIENT. THE PICTURE WILL RETURN.

If the antenna does not sense vehicle motion after several minutes, it will enter sleep mode. The antenna will automatically wake and begin tracking if it senses vehicle motion or a severe drop in satellite signal.

When you park for the evening or any extended period, it is recommended that you perform a stationary search.

## AUTOMATIC SATELLITE SWITCHING

1. After you have properly configured the VuQube antenna for your satellite service, the VuQube will automatically switch between satellites by simply selecting your desired channel using the receiver's remote control.

Note: For better performance when using the automatic satellite switching feature, change channels by selecting your program from the channel guide rather than channel surfing.

It is common for the picture to pixel or display an error message when the antenna is switching between satellites, or the signal has been temporarily blocked. PLEASE BE PATIENT. THE PICTURE WILL RETURN.

If an error message appears for an extended period, selecting CANCEL may help clear the message more quickly.

Dish Network HD users: If you are unable to receive all of your HD programming, see **Dish Network HDTV: Changing the Satellite Trio** on page 22.

# DISH NETWORK HDTV: Changing the Satellite Trio

## Dish HD Trio and Dish HD Eastern Arc Trio

**IMPORTANT!** Perform this procedure only if you are unable to receive all of your HD programming in a particular area of the country.

You cannot change trios if the antenna has not been initially configured for Dish HD or Dish HD Eastern Arc (page 14).

You can only switch between the Dish HD and Dish HD Eastern Arc Trios. The Dish HD Alternate Trio is not included in this function.

Dish Network HD programming is broadcast from multiple satellites including these two trios:

- the Dish HD Trio: 110, 119, 129 satellites
- the Dish HD Eastern Arc Trio: 62, 72, 77 satellites

The map below shows the approximate coverage for each trio.

The VuQube antenna can be easily configured to work with either trio as you travel from one coverage area to another. By choosing the appropriate trio based on where you are, you can receive all of your desired programming.

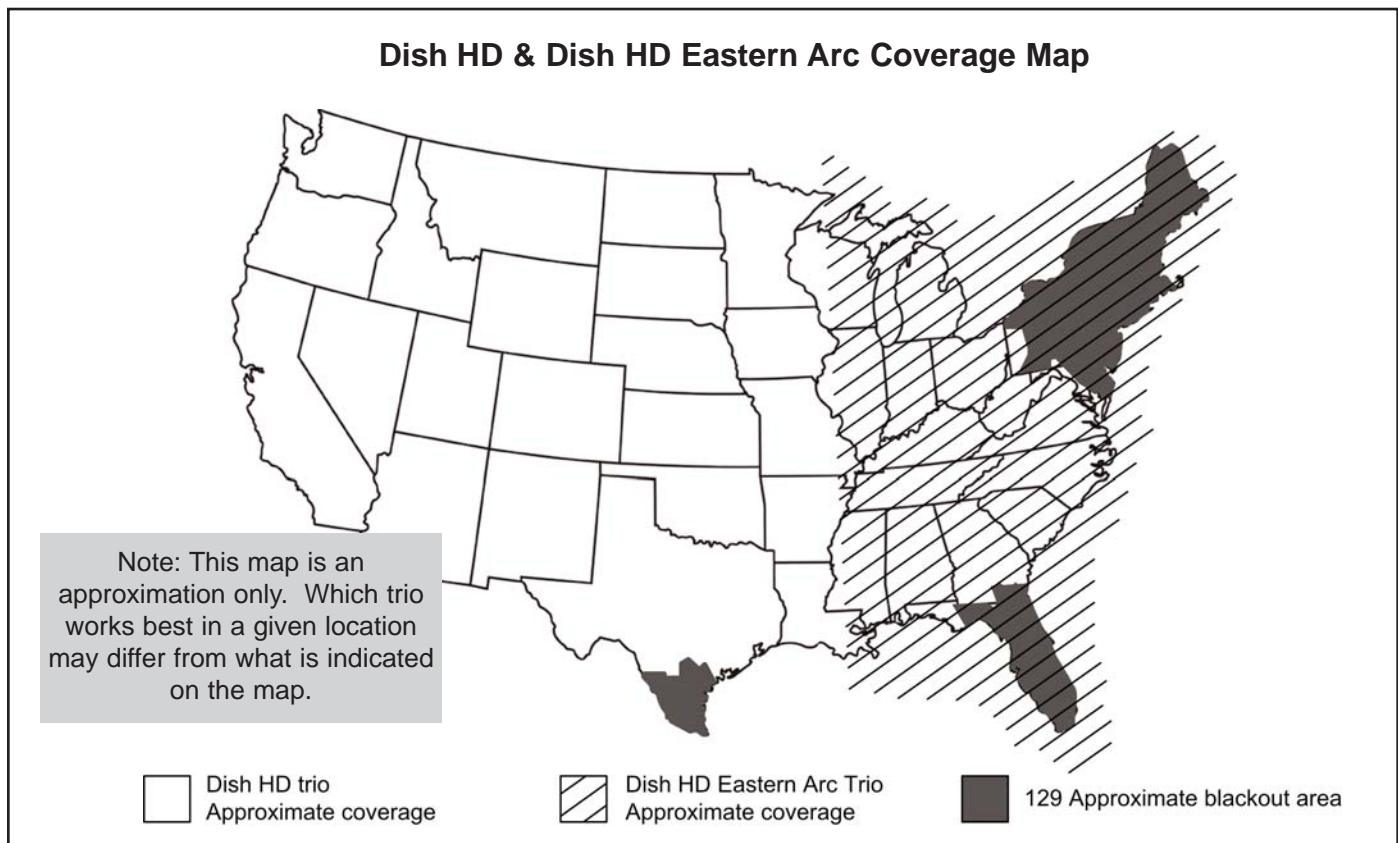



**Change from: DISH HD Eastern Arc Trio (62, 72, 77)**

**To: DISH HD Trio (110, 119, 129)**

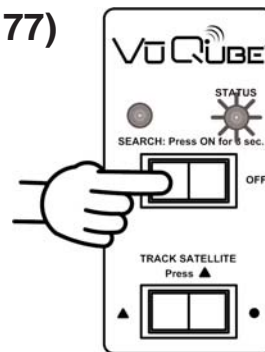

1. On the VuQube controller, press and release the ON button. Wait for the status light to flash orange, and then **WAIT 4 MORE SECONDS**.
2. Press and release the ON button **4** times.  
The status light starts rapidly flashing green and red.
3. Press and hold the ● button for 4 seconds.  
The status light will turn orange for 1 second, and then start flashing green or red.
4. Press OFF. **GO TO PAGE 18 AND RUN THE CHECK SWITCH.**

**IMPORTANT! YOU MUST RUN THE CHECK SWITCH AFTER SWITCHING TRIOS!**

**Change from: DISH HD Trio (110, 119, 129)**

**To: DISH HD Eastern Arc Trio (62, 72, 77)**

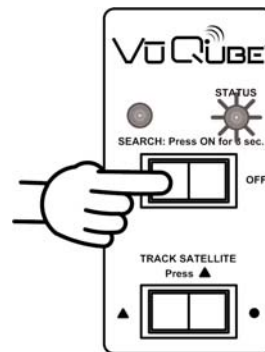

1. On the VuQube controller, press and release the ON button. Wait for the status light to flash orange, and then **WAIT 4 MORE SECONDS**.
2. Press and release the ON button **4** times.  
The status light starts rapidly flashing green and red.
3. Press and hold the ▲ button for 4 seconds.  
The status light will turn orange for 1 second, and then start flashing green or red.
4. Press OFF. **GO TO PAGE 18 AND RUN THE CHECK SWITCH.**

**IMPORTANT! YOU MUST RUN THE CHECK SWITCH AFTER SWITCHING TRIOS!**

## SECTION 5

**TROUBLESHOOTING**

SYMPTOM	POSSIBLE REASON	COURSE OF ACTION
VuQube does not find satellite. (STATUS light flashes red or green.)	Did not hold ON button for <u>3 FULL SECONDS.</u>	Hold ON button for <u>3 FULL SECONDS.</u>
STATUS light flashes orange.	Before search: bad coax connection.  After unsuccessful search (approximately 25 minutes): obstruction in line of sight between VuQube and satellite.	Call King Controls.  Move vehicle so VuQube has unobstructed view of southern sky.
STATUS light does not stop rapidly flashing red and green.	Self check failed: potential motor problem.	Call King Controls.
STATUS light does not turn on or is dim.	Bad power source (low voltage).  Bad power or controller cable connection at antenna unit.  Bad controller cable connection at controller.	Call King Controls.
STATUS light is steady green but no picture.	Satellite receiver is off or requires reset.	Turn on receiver or reset (see page 20).
I don't get all of my channels.	One of your satellites is blocked.  Dish HD/Dish HD Eastern Arc ONLY: You have traveled outside the coverage area of your selected trio.	Move vehicle so VuQube has unobstructed view of southern sky.  Dish HD/Dish HD Eastern Arc ONLY: Change your satellite trio (see page 22).

The VuQube Satellite System has been designed to be maintenance and trouble free.

For optimum signal strength, keep the enclosure clean from dirt, bugs, and other debris. Periodic washing of the enclosure with mild soap and water is recommended.

If you plan on not using your VuQube for long periods of time, it is recommended that the system be put through a search procedure on a quarterly basis to keep all moving parts in good working order.

If you have any comments or questions, please contact the King Controls Service Department at (800) 982-9920, or email King Controls at [info@vuqube.com](mailto:info@vuqube.com)

### Rain Fade

Rain or dew on the enclosure can cause signal interference and make the digital picture freeze, pixel or go out altogether. This loss of signal is commonly referred to as “rain fade” and is caused by the combination of water in the atmosphere and water on the enclosure surface.

To minimize this issue and eliminate the effects of water on the enclosure, apply King Controls **Dome Magic**® rain fade solution to the enclosure. This will prevent water from sticking to the enclosure surface and blocking the signal. For additional details on **Dome Magic**® rain fade solution please contact your authorized VuQube dealer or call King Controls at (800) 982-9920.



Single Application Packet #1830-SP



Spray Can #1830

Note: **Dome Magic**® will discolor VuQubes painted a dark color.

Every VuQube Satellite System is thoroughly inspected and tested before leaving the factory. It is covered by a one year parts limited warranty from the date of original purchase. This warranty does not cover installation and external wiring or refurbished units.

Should any trouble develop during the warranty period, contact King Controls. Only King Controls may perform warranty evaluations and repairs.

If it is determined that the unit needs to be returned, return COMPLETE product, freight prepaid, to: **King Controls, 11200 Hampshire Ave. S., Bloomington, MN 55438-2453.**

If inspection shows the trouble is caused by defective workmanship or material, King Controls will repair the unit without charge.

This warranty does not apply where:

- The product has been abused, misused, improperly installed or improperly maintained.
- Repairs have been made or attempted by others.
- Repairs are required because of normal wear and tear.
- Alterations have been made to the product.

**In no event shall King Controls be liable for any indirect, incidental, or consequential damages from the sale or use of the product. This disclaimer applies both during and after the term of the warranty.**

**King Controls disclaims liability for any implied warranties, including implied warranties of “merchantability” and “fitness for a specific purpose,” after the one year term of this warranty.**

This warranty gives you specific legal rights, and you may also have other rights, which vary from state to state. Some states do not allow the exclusion or limitation of incidental or consequential damages, so the above limitation or exclusion may not apply to you. Some states do not allow limitations on how long an implied warranty lasts, so the above limitation may not apply to you.

## Notes:

## Notes:





11200 Hampshire Avenue South, Bloomington, MN 55438-2453  
Phone: (800) 982-9920 Fax: (952) 922-8424

[www.kingcontrols.com](http://www.kingcontrols.com)

